

tBOX810-838-FL

Fanless Embedded System with Intel® Atom™ Processor E3845/E3827 for Vehicle, Railway and Marine PC



▲ Front view

Specifications

Standard Color	Silver-Black	
Construction	Aluminum extrusion and heavy-duty steel	
CPU	Intel® Atom™ processor E3845 (4C@1.91 GHz) Intel® Atom™ processor E3827 (2C@1.75 GHz)	
System Memory	DDR3L-1333, 4 GB memory onboard	
Chipset	SoC integrated	
BIOS	AMI	
System I/O Outlet	Rear Side	Option #1: 2 x M12 A-coded GbE LAN + 1x M12 A-coded DC power input Option #2: 2 x RJ-45 GbE LAN + 1 x Phoenix DC power input (Intel® i210 LAN chip x2) 2 x audio (mic-in/line-out) (optional)
	Front Side	2 x RS-232/422/485 1 x DI/DO (8bit programmable) 1 x VGA 2 x USB 2.0 1 x remote switch 1 x reset button 4 x antenna opening
Watchdog Timer	255 levels, 0 ~ 255 seconds/minutes	
Storage	1 x 2.5" 9.5 mm SATA drive 1 x mSATA	
Expansion Interface	2 x full-size mini PCIe card slots, 1x supported mSATA 1 x SIM card socket	
System Indicator	1 x green LED indicator for system power 1 x green LED indicator for programmable #1 1 x green LED indicator for programmable #2 1 x yellow LED indicator for HDD active 1 x green LED indicator for LAN #1 active 1 x green LED indicator for LAN #2 active	
Power Supply	Power input: 9 ~ 36VDC typical: 12/24VDC	
Operating Temperature	-40°C ~ +70°C (-40°F ~ +158°F) with W.T. SSD -25°C ~ +55°C (-13°F ~ +131°F) with W.T. HDD	
Storage Temperature	-40°C ~ +80°C (-40°F ~ +176°F)	
Humidity	5% ~ 95%, non-condensing	
Vibration Endurance	3 Grms w/ SSD (5-500Hz, X, Y, Z direction; random) 1 Grms w/ HDD (5-500Hz, X, Y, Z direction; random)	

- eMark, ISO7637, EN50155, EN50121 and IEC60945 certificated
- Intel® Atom™ Bay Trail-I E3845 4C@1.91 GHz or E3827 2C@1.75GHz
- DDR3L-1333 4 GB system memory onboard
- Fanless with operating temperature range of -40°C ~ +70°C (EN50155 class TX)
- Intelligent power management solution
- Compact size with rich multiple I/Os, DIN rail and wall mount supported
- 2 full size mini PCIe card slots and 1 SIM card socket

Shock	Comply EN 61373 section 10 table 3 category 1 class A and class B up to 5Grms (30ms, ±X/Y/Z direction)
Dimensions	163.8 mm (6.44") (W) x 108 mm (4.25") (D) x 44 mm (1.73") (H)
Weight (net/gross)	0.77 kg (1.69 lb)/ TBC
Certificate	CE (Class A), EN50155, EN50121, eMark, ISO7637, IEC60945 certificated
EOS support	WE8S, WES 7, Linux

Ordering Information

Standard	
tBOX810-838-FL-E3827-M12-DC	Fanless Vehicle/Railway/Marine embedded system, with Intel® Atom™ E3827 1.75GHz processor, 4GB DRAM, 2 USB, VGA, 2 GbE LAN (M12), M12 DC-in, 2 COM, DIO (8bit programmable)
tBOX810-838-FL-E3827-RJ-DC	Fanless Vehicle/Railway/Marine Grade embedded system with Intel® Atom™ E3827 1.75GHz processor, 4GB DRAM, 2 USB, VGA, 2 GbE LAN, Phoenix DC-in, 2 COM, DIO (8bit programmable)
tBOX810-838-FL-E3827-M12-ACC-DC	Fanless Vehicle/Railway/Marine Grade embedded system with Intel® Atom™ E3827 1.75GHz processor, 4GB DRAM, 2 USB, VGA, 2 GbE LAN (M12), M12 DC-in, 2 COM, DIO, DIO(8bit programmable) with ACC power setting for vehicle
tBOX810-838-FL-E3845-M12-DC	Fanless Vehicle/Railway/Marine Grade embedded system with Intel® Atom™ E3845 1.91GHz processor, 4GB DRAM, 2 USB, VGA, 2 GbE LAN (M12), M12 DC-in, 2 COM, DIO (8bit programmable)
tBOX810-838-FL-E3845-RJ-DC	Fanless Vehicle/Railway/Marine Grade embedded system with Intel® Atom™ E3845 1.91GHz processor, 4GB DRAM, 2 USB, VGA, 2 GbE LAN, Phoenix DC-in, 2 COM, DIO (8bit programmable)
tBOX810-838-FL-E3845-M12-ACC-DC	Fanless Vehicle/Railway/Marine Grade embedded system with Intel® Atom™ E3845 1.91GHz processor, 4GB DRAM, 2 USB, VGA, 2 GbE LAN (M12), M12 DC-in, 2 COM, DIO (8bit programmable) with ACC power setting for vehicle
Optional	
2.5" SATA HDD/SSD mSATA SSD 3G/4G module Wi-Fi module Wi-Fi & bluetooth GPS module CANbus module Video card module	

*Specifications and certifications are based on options and may vary.

Архангельск (8182)63-90-72

Астана +7(7172)727-132

Белгород (4722)40-23-64

Брянск (4832)59-03-52

Владивосток (423)249-28-31

Волгоград (844)278-03-48

Вологда (8172)26-41-59

Воронеж (473)204-51-73

Екатеринбург (343)384-55-89

Иваново (4932)77-34-06

Ижевск (3412)26-03-58

Казань (843)206-01-48

Калининград (4012)72-03-81

Калуга (4842)92-23-67

Кемерово (3842)65-04-62

Киров (8332)68-02-04

Краснодар (861)203-40-90

Красноярск (391)204-63-61

Курск (4712)77-13-04

Липецк (4742)52-20-81

Магнитогорск (3519)55-03-13

Москва (495)268-04-70

Мурманск (8152)59-64-93

Набережные Челны (8552)20-53-41

Нижний Новгород (831)429-08-12

Новокузнецк (3843)20-46-81

Новосибирск (383)227-86-73

Орел (4862)44-53-42

Оренбург (3532)37-68-04

Пенза (8412)22-31-16

Пермь (342)205-81-47

Ростов-на-Дону (863)308-18-15

Рязань (4912)46-61-64

Самара (846)206-03-16

Санкт-Петербург (812)309-46-40

Саратов (845)249-38-78

Смоленск (4812)29-41-54

Сочи (862)225-72-31

Ставрополь (8652)20-65-13

Тверь (4822)63-31-35

Томск (3822)98-41-53

Тула (4872)74-02-29

Тюмень (3452)66-21-18

Ульяновск (8422)24-23-59

Уфа (347)229-48-12

Челябинск (351)202-03-61

Череповец (8202)49-02-64

Ярославль (4852)69-52-93

Expansion & Installation



Compact size 163.8 x 108 x 44 mm, such thin and light as palm size

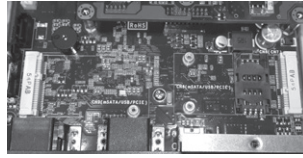

2 x mini PCIe card slots + 1x SIM card socket
Excellent extensibility in such compact size



Optional I/O ports Option for audio, LAN jack type and DC-in jack type

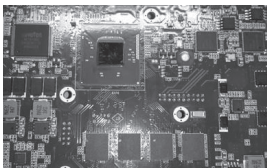

Onboard processor and system memory
Comes with great reliability and stability



Simple storage maintenance



DIN rail, wall mount supported
For various application, without space limitation

Packing List

- 1 x quick manual
- 1 x driver CD
- 1 x screw pack
- 4 x foot pad
- 1 x wall-mount kit
- 1 x DIN rail kit

Power Protection

DC Version

- SCP (short circuit protection)
- OVP (over voltage protection)
- UVP (under voltage protection)
- ISO7637 pulse 1/2/3/4/5a
- Battery protection setting: Low voltage, Very low voltage
- Ignition control setting: Low voltage counter, ACC-ON delay, Shut down delay

Dimensions

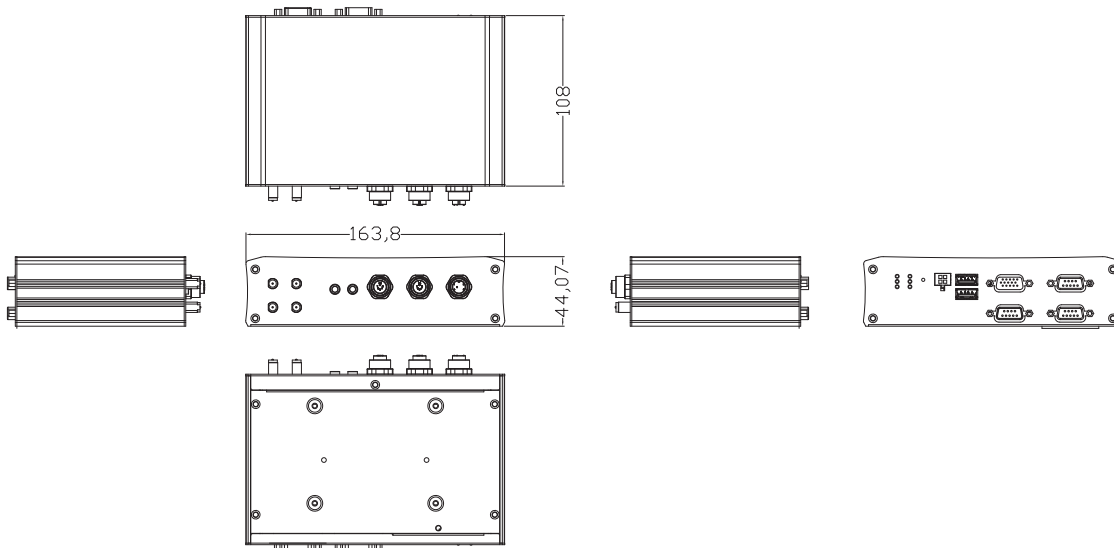

tBOX311-820-FL

Fanless Embedded System with Intel® Atom™ Processor Z520PT 1.33 GHz for Vehicle PC

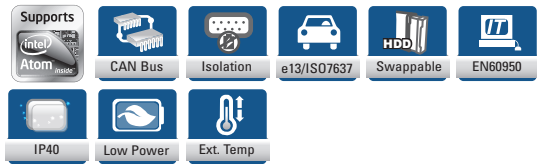
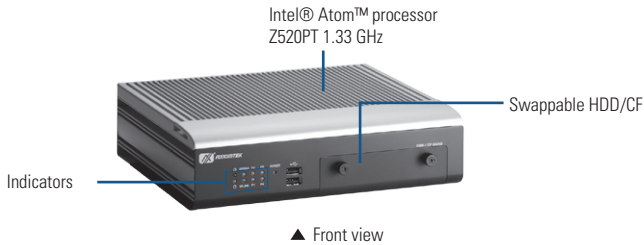

Specifications

Standard Color	Silver-Black				
Construction	Aluminum extrusion and heavy-duty steel				
CPU	Intel® Atom™ processor Z520PT 1.33 GHz onboard				
System Memory	1 x 200-pin DDR2 SO-DIMM max. up to 2 GB				
Chipset	Intel® US15WPT				
BIOS	AMI				
System I/O Outlet	<table border="0"> <tr> <td>Rear Side</td> <td> 2 x GbE LAN 1 x isolated RS-232/422/485 1 x isolated DI/DO (4-in/4-out) 1 isolated CAN Bus (optional RS-232/422/485) 2 x USB 2.0 2 x audio (mic-in/line-out) 2 x VGA 1 x VDC power input 1 x 12V/24V DC input switch 3 x antenna opening </td> </tr> <tr> <td>Front Side</td> <td> 2 x USB 2.0 1 x reset switch 1 x 2.5" SATA drive trays </td> </tr> </table>	Rear Side	2 x GbE LAN 1 x isolated RS-232/422/485 1 x isolated DI/DO (4-in/4-out) 1 isolated CAN Bus (optional RS-232/422/485) 2 x USB 2.0 2 x audio (mic-in/line-out) 2 x VGA 1 x VDC power input 1 x 12V/24V DC input switch 3 x antenna opening	Front Side	2 x USB 2.0 1 x reset switch 1 x 2.5" SATA drive trays
Rear Side	2 x GbE LAN 1 x isolated RS-232/422/485 1 x isolated DI/DO (4-in/4-out) 1 isolated CAN Bus (optional RS-232/422/485) 2 x USB 2.0 2 x audio (mic-in/line-out) 2 x VGA 1 x VDC power input 1 x 12V/24V DC input switch 3 x antenna opening				
Front Side	2 x USB 2.0 1 x reset switch 1 x 2.5" SATA drive trays				
Watchdog Timer	255 levels, 0 ~ 255 sec./min.				
Storage	1 x 2.5" SATA HDD drive bay 1 x CompactFlash™				
Expansion Interface	3 x PCI Express Mini Card 1 x SIM card slot				
System Indicator	1 x green LED for system power-on 1 x red LED for HDD active 1 x green LED for WWAN 1 x programmable LED (P1-P4)				
Power Supply	DC12V mode: Operating voltage: DC9 ~ 16V Start voltage: DC12V or higher DC24V mode: Operating voltage: DC18 ~ 32V Start voltage: DC24V or higher				
Power Consumption	1.7A @ 12V 0.9A @ 24V				
Operating Temperature	-40°C ~ +65°C (-40°F ~ +149°F) (with 1.33 GHz CPU, W.T. HDD)				
Storage Temperature	-40°C ~ +80°C (-4°F ~ +176°F)				
Humidity	10% ~ 90% , non-condensing				
Vibration Endurance	2 Grms with CF (5-500Hz, X, Y, Z directions)				

Features

- eMark, ISO7637 certificates
- Intel® Atom™ processor Z520PT 1.33 GHz
- Intel® US15WPT
- Fanless with operating temperature range of -40°C ~ +65°C
- 1 isolated RS-232/422/485 and 1 isolated CAN bus (optional for RS-232/422/485)
- High performance DDR2-667 SODIMM max. up to 2 GB
- One 2.5" swappable SATA drive bay and 1 CompactFlash™ slot
- 3 internal PCI Express Mini Card slots with 1 SIM slot

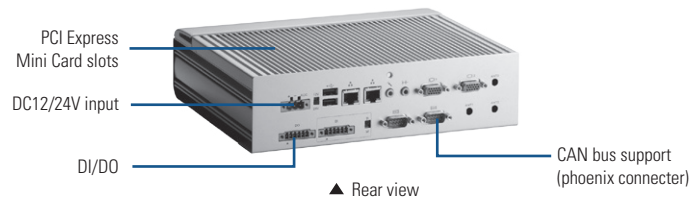

Dimensions	244 mm (9.6") (W) x 185.4 mm (7.3") (D) x 70.4 mm (2.77") (H)
Weight (net/gross)	2.5 kg (5.5 lb)/3.5 kg (7.7 lb)
Certificate	CE, e13, ISO7637, EN60950 compliance
EOS Support	XPE, WinCE, Linux

Ordering Information

Standard	
tBOX311-820-FL1.33G-CAN	Fanless vehicle embedded system with Intel® Atom™ Z520PT 1.33 GHz processor, 2 VGA, CFast & HDD support, 2 GbE LAN, 1 RS-232/422/485, 1 CAN and 4 USB
tBOX311-820-FL1.33G-COM	Fanless vehicle embedded system with Intel® Atom™ Z520PT 1.33 GHz processor, 2 VGA, CFast & HDD support, 2 GbE LAN, 2 RS-232/422/485 and 4 USB
Optional	
2.5" SATA HDD	40 GB or above
DDR2 SODIMM	512 MB or above
CompactFlash™ 3G module	1 GB or above
Wi-Fi module	
Wi-Fi Bluetooth	
GPS module	
Graphic accelerator codec	

*Specifications and certifications are based on options and may vary.

Expansion & Installation

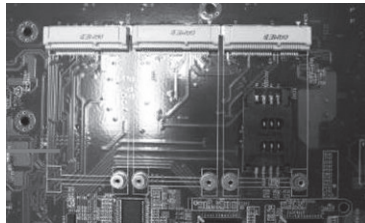
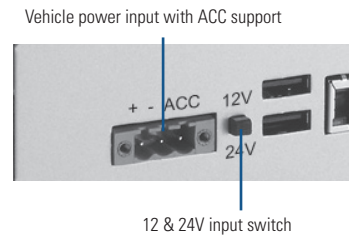
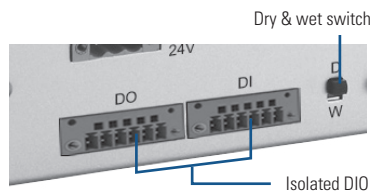
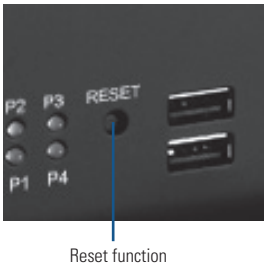

3 x Mini Card with SIM



Intel® Z520PT with US15WPT supports wide temperature of -40°C ~ +70°C

Ordering Information

- 1 x quick manual
- 1 x driver CD
- 1 x screw pack
- 4 x foot pad
- 4 x HDD anti-vibration damper
- 1 x wallmount Kit

Power Protection

- DC Version**
- ISO7637 pulse1/2a/3a/3b/4/5a
 - OVP (over voltage protection)
 - UVP (under voltage protection)
 - OCP (over current protection)
 - OTP (over temperature protection)
 - OPP (over power protection)
 - OLD (over load protection)
 - SCP (short circuit protection)
 - Reverse protection
 - Battery-low protection

Dimensions

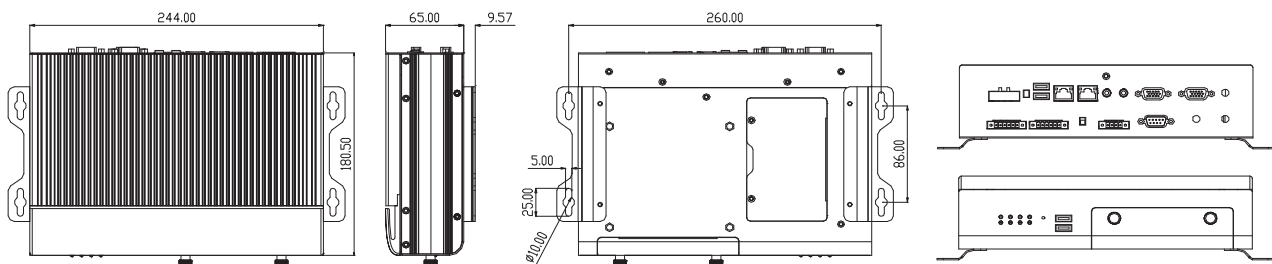

tBOX312-870-FL

Fanless Embedded System with 3rd Generation Intel® Core™ Processor and Intel® QM77 for Vehicle PC

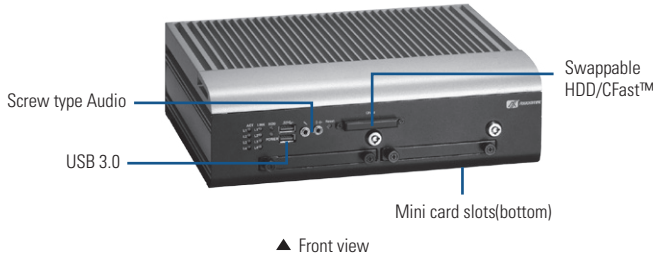

Specifications

Standard Color	Silver-Black				
Construction	Aluminum extrusion and heavy-duty steel, IP40				
CPU	3rd generation Intel® Core™ processor ; 3rd generation Intel® Core™ i7-3517UE (1.7 GHz up to 2.8 GHz) or 3rd generation Intel® Core™ i3-3217UE (1.6 GHz)				
System Memory	DDR3-1600 4 GB DRAM onboard				
Chipset	Intel® QM77				
BIOS	AMI UEFI BIOS with OA 3.0 built				
System I/O Outlet	<table border="0"> <tr> <td>Rear Side</td> <td> <ul style="list-style-type: none"> 4 x GbE LAN 3 x isolated RS-232/422/485 1 x isolated DI/DO (4-in/4-out) 1 x isolated CAN Bus 2 x USB 2.0 2 x audio (mic-in/line-out, screw type) 1 x VGA 1 x DVI-D 1 x VDC power input 1 x remote power switch 4 x antenna opening </td> </tr> <tr> <td>Front Side</td> <td> <ul style="list-style-type: none"> 2 x USB 3.0 2 x audio (mic-in/line-out, screw type) 1 x reset switch 2 x 2.5" SATA drive trays 1 x CFast™ slot </td> </tr> </table>	Rear Side	<ul style="list-style-type: none"> 4 x GbE LAN 3 x isolated RS-232/422/485 1 x isolated DI/DO (4-in/4-out) 1 x isolated CAN Bus 2 x USB 2.0 2 x audio (mic-in/line-out, screw type) 1 x VGA 1 x DVI-D 1 x VDC power input 1 x remote power switch 4 x antenna opening 	Front Side	<ul style="list-style-type: none"> 2 x USB 3.0 2 x audio (mic-in/line-out, screw type) 1 x reset switch 2 x 2.5" SATA drive trays 1 x CFast™ slot
Rear Side	<ul style="list-style-type: none"> 4 x GbE LAN 3 x isolated RS-232/422/485 1 x isolated DI/DO (4-in/4-out) 1 x isolated CAN Bus 2 x USB 2.0 2 x audio (mic-in/line-out, screw type) 1 x VGA 1 x DVI-D 1 x VDC power input 1 x remote power switch 4 x antenna opening 				
Front Side	<ul style="list-style-type: none"> 2 x USB 3.0 2 x audio (mic-in/line-out, screw type) 1 x reset switch 2 x 2.5" SATA drive trays 1 x CFast™ slot 				
Watchdog Timer	255 levels, 0 ~ 255 sec./min.				
Storage	2 x 2.5" SATA HDD (Removable and with lock protection) supports RAID 0/1 1 x CFast™				
Expansion Interface	3 x PCI Express Mini Card 1 x SIM card slot				
System Indicator	<ul style="list-style-type: none"> 1 x green LED for system power on 1 x blue LED for HDD active 1 x green LED for LAN1 link 1 x green/yellow LED for LAN 1 speed 1 x green LED for LAN2 link 1 x green/yellow LED for LAN 2 speed 1 x green LED for LAN3 link 1 x green/yellow LED for LAN 3 speed 1 x green LED for LAN4 link 1 x green/yellow LED for LAN 4 speed 				

Features

- eMark, ISO7637 certificates
- Comply to fire protection of railway vehicles Europe standard PrCEN TS 45545-2
- 3rd generation Intel® Core™ i7 1.7 GHz up to 2.8 GHz or Intel® Core™ i3 1.6 GHz processor
- High performance DDR3-1600 4 GB memory
- Fanless with operating temperature range of -40°C ~ +70°C
- Isolated RS-232/422/485, CAN bus and DIO
- Supports USB 3.0 and SATA3
- 2 removable & lockable 2.5" SATA HDD and 1 CFast™
- 3 internal PCI Express Mini Card slot and 1 SIM slot
- IEEE802.3at PoE Gigabit LAN

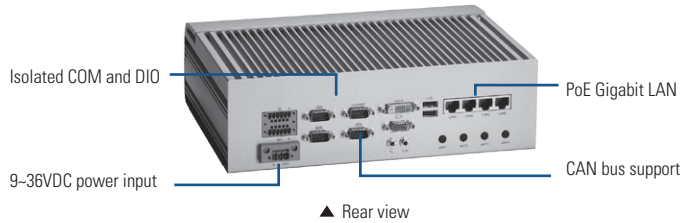

Power Supply	Power input : 9 ~ 36VDC, typical 12/24VDC
Power Consumption	1.8A @ 24V (without PoE) PoE power output max 30W
Operating Temperature	-40°C ~ +70°C (-40°F ~ +158°F) W/T SSD -25°C ~ +55°C (-13°F ~ +131°F) W/T HDD
Storage Temperature	-40°C ~ +80°C (-40°F ~ +176°F)
Humidity	5% ~ 95%, non-condensing
Vibration Endurance	5 Grms with CFast™ (5-500Hz, X, Y, Z directions) 1 Grms with HDD (5-500Hz, X, Y, Z directions)
Dimensions	288 mm (11.33") (W) x 211 mm (8.3") (D) x 85.7 mm (3.37") (H)
Weight (net/gross)	5.5 kg (12.12 lb)/6.5 kg (14.33 lb)
Certificate	CE (Class A), e13, ISO7637, EN60950 compliance
EOS Support	WEBS, WES 7, Linux

Ordering Information

Standard

tBOX312-870-FL-i7-DC	Fanless vehicle embedded system with 3rd generation Intel® Core™ i7 processor, 4GB DDR3-1600, 4 GbE PoE Ethernet, 3 isolated COM, CFast™ and isolated CAN bus
tBOX312-870-FL-i3-DC	Fanless vehicle embedded system with 3rd generation Intel® Core™ i3 processor, 4GB DDR3-1600, 4 GbE PoE Ethernet, 3 isolated COM, CFast™ and isolated CAN bus

Optional

2.5" SATA HDD/SSD	16 GB or above
CFast™	1 GB or above
3G module	
Wi-Fi module	
Wi-Fi Bluetooth	
GPS module	

*Specifications and certifications are based on options and may vary.

Expansion & Installation

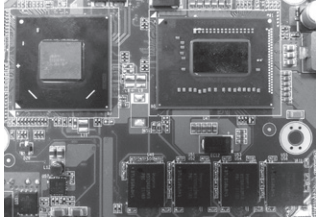

Onboard 3rd generation Intel® Core™ i7 or i3 processor and 4 GB DDR3-1600 DRAM



Swappable and Lockable SATA3 HDD/SSD, Audio jack, USB 3.0 and CFast

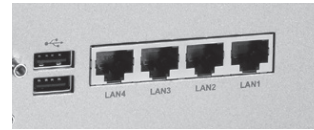

IEEE802.3at PoE Gigabit LAN

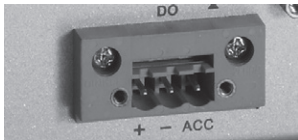

Vehicle power input with ACC support

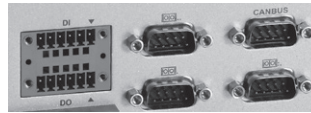

Isolated RS-232/422/485, CAN bus and DIO

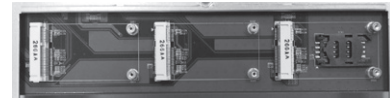

3 PCIe Mini Card slots with 1 SIM slot

Packing List

- 1 x quick manual
- 1 x driver CD
- 1 x screw pack
- 4 x foot pad
- 1 x wall-mount kit

Power Protection

DC Version

- SCP (short circuit protection)
- OVP (over voltage protection)
- UVP (under voltage protection)
- ISO7637 pulse 1/29/39/3b/4/5a

Dimensions

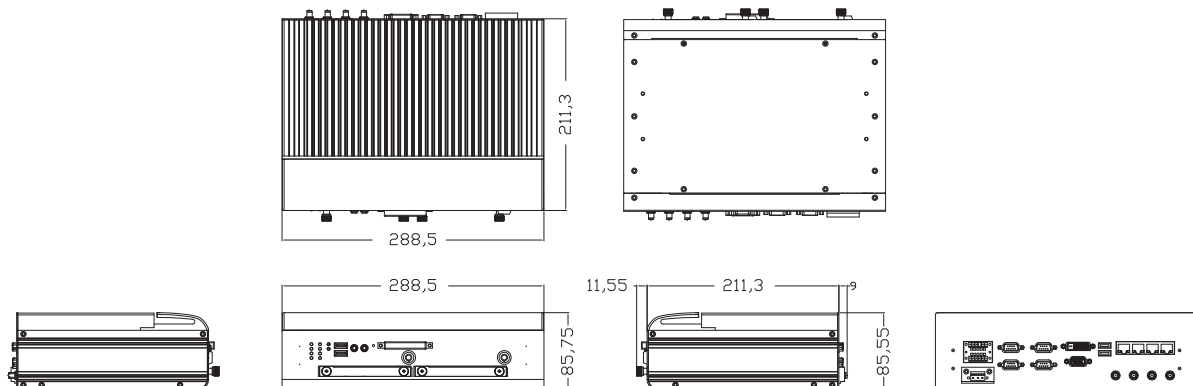

tBOX313-835-FL

Fanless Embedded System with Intel® Atom™ Processor E3845 Quad Core™ (1.91 GHz) for Vehicle PC



▲ Front view



Specifications

Standard Color	Silver-Black				
Construction	Aluminum extrusion and heavy-duty steel				
CPU	Intel® Atom™ processor E3845 (4C@1.91 GHz)				
System Memory	DDR3L-1333, 4 GB memory onboard				
Chipset	SoC integrated				
BIOS	AMI				
System I/O Outlet	<table border="0"> <tr> <td>Rear Side</td> <td> 2 x GbE LAN (M12 D-coded)(RJ-45, PoE is optional) 4 x isolated RS-422/485 1 x RS-232 1 x isolated DI/DO (6-in/2-out) 1 x isolated CAN Bus 2 x audio (mic-in/line-out, screw type) 1 x VGA 1 x HDMI 1 x HDMI bracket hole 1 x VDC power input 1 x fuse 4 x antenna opening </td> </tr> <tr> <td>Front Side</td> <td> 2 x USB 2.0 2 x audio (mic-in/line-out, screw type) 1 x reset switch 1 x remote power switch 1 x 2.5" SATA drive tray 1 x CFAST™ slot + 2 x SIM card sockets </td> </tr> </table>	Rear Side	2 x GbE LAN (M12 D-coded)(RJ-45, PoE is optional) 4 x isolated RS-422/485 1 x RS-232 1 x isolated DI/DO (6-in/2-out) 1 x isolated CAN Bus 2 x audio (mic-in/line-out, screw type) 1 x VGA 1 x HDMI 1 x HDMI bracket hole 1 x VDC power input 1 x fuse 4 x antenna opening	Front Side	2 x USB 2.0 2 x audio (mic-in/line-out, screw type) 1 x reset switch 1 x remote power switch 1 x 2.5" SATA drive tray 1 x CFAST™ slot + 2 x SIM card sockets
Rear Side	2 x GbE LAN (M12 D-coded)(RJ-45, PoE is optional) 4 x isolated RS-422/485 1 x RS-232 1 x isolated DI/DO (6-in/2-out) 1 x isolated CAN Bus 2 x audio (mic-in/line-out, screw type) 1 x VGA 1 x HDMI 1 x HDMI bracket hole 1 x VDC power input 1 x fuse 4 x antenna opening				
Front Side	2 x USB 2.0 2 x audio (mic-in/line-out, screw type) 1 x reset switch 1 x remote power switch 1 x 2.5" SATA drive tray 1 x CFAST™ slot + 2 x SIM card sockets				
Instant Fuse Repair	Current Rating 15A, Voltage Rating: 125V				
Watchdog Timer	255 levels, 0 ~ 255 seconds/minutes				
Storage	1 x 2.5" SATA HDD (suspension designed, HDD height supports 7/9.5/12.5/15 mm) 1 x CFAST™ (front accessible)				
Expansion Interface	3 x PCI Express Mini Card with 2 x SIM card slot (two front accessible) 1x PCIe mini card supports mSATA				
System Indicator	1 x green LED for HDD active 1 x yellow LED for LAN1 active 1 x yellow LED for LAN2 active 1 x red LED for power				

Features

- eMark, ISO7637 certificated, EN45545-2 complied
- Intel® Atom™ Bay Trail-I E3845 4C@1.91 GHz
- High performance DDR-1333 4 GB memory onboard
- Fanless operation with IP40
- Operating temperature range of -40°C ~ +70°C
- Isolated RS-422/485, CANbus 2.0A/B and DIO ports
- Supports USB 2.0 and SATA2
- Suspension one 2.5" SATA HDD and 1 CFAST™ socket
- Instant fuse repair design
- Internal mini PCIe slots and SIM socket

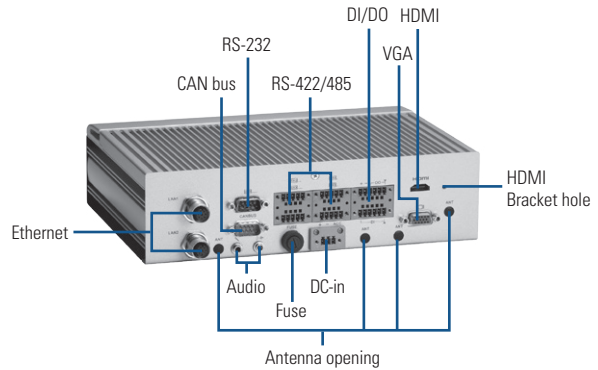

▲ Rear view

Power Supply	Power input : Typical 12/24vdc (9 ~ 36 Vdc)
Operating Temperature	-40°C ~ +70°C (-40°F ~ +158°F) with W/T SSD -25°C ~ +55°C (-13°F ~ +131°F) with W/T HDD
Storage Temperature	-40°C ~ +80°C (-40°F ~ +176°F)
Humidity	5% ~ 95%, non-condensing
Vibration Endurance	3 Grms with SSD & CFAST™ (5-500Hz, X, Y, Z direction; Random) (IEC60068-2-34) 2 Grms with HDD (5-500Hz, X, Y, Z direction; Random)
Dimensions	244 mm (9.6") (W) x 180.5 mm (7.1") (D) x 65.1 mm (2.56") (H)
Weight (net/gross)	3 kg (6.61 lb)/ 4 kg (8.82 lb)
Certificate	CE, eMark, ISO 7637, EN45545-2 compliance
EOS support	WES7/8, Compac2013, Linux

Ordering Information

Standard

tBOX313-835-FL-M12-DC	Fanless vehicle embedded system, with Intel® Atom™ E3845 1.91 GHz processor, 4 GB DRAM, 2 USB, 1 CAN bus, 2 M12 GbE LAN, 4 RS-422/485, 1 RS-232 and DIO (6-in/2-out)
tBOX313-835-FL-M12-POE-DC	Fanless vehicle embedded system, with Intel® Atom™ E3845 1.91 GHz processor, 4 GB DRAM, 2 USB, 1 CAN bus, 2 PoE M12 GbE LAN, 4 RS-422/485, 1 RS-232 and DIO (6-in/2-out)
tBOX313-835-FL-RJ-DC	Fanless vehicle embedded system, with Intel® Atom™ E3845 1.91 GHz processor, 4 GB DRAM, 2 USB, 1 CAN bus, 2 RJ-45 GbE LAN, 4 RS-422/485, 1 RS-232 and DIO (6-in/2-out)
tBOX313-835-FL-RJ-POE-DC	Fanless vehicle embedded system, with Intel® Atom™ E3845 1.91 GHz processor, 4 GB DRAM, 2 USB, 1 CAN bus, 2 PoE RJ-45 GbE LAN, 4 RS-422/485, 1 RS-232 and DIO (6-in/2-out)

Optional

- 2.5" SATA HDD/SSD
- CFAST™
- 3G module
- Wi-Fi module
- Wi-Fi & bluetooth
- GPS module

*Specifications and certifications are based on options and may vary.

Expansion & Installation

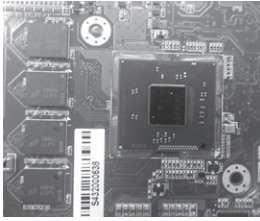

Onboard Intel® Atom™ Bay Trail-I E3845, 4C@ 1.91 GHz processor and 4 GB DDR3L-1333 DRAM



Removable CFast™, SIM slot and suspension 2.5" SATA HDD/SSD



M12 railway power input and two Gigabit LAN connectors



HDMI and VGA display

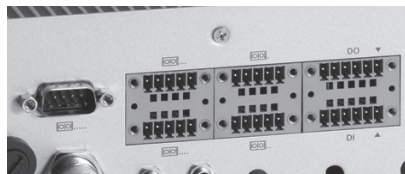

Isolated RS-422/485 and DIO ports

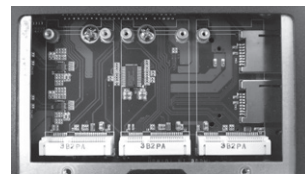

3 x Mini Card with 2 x SIM slot

Packing List

- 1 x quick manual
- 1 x driver CD
- 1 x screw pack
- 4 x foot pad
- 1 x wall-mount kit

Power Protection

DC Version

- SCP (short circuit protection)
- OVP (over voltage protection)
- UVP (under voltage protection)
- ISO7637 pulse 1/29/39/3b/4/5a
- Battery protection setting: Low voltage, Very low voltage
- Ignition control setting: Low voltage counter, ACC-ON delay, Shut down delay

Dimensions

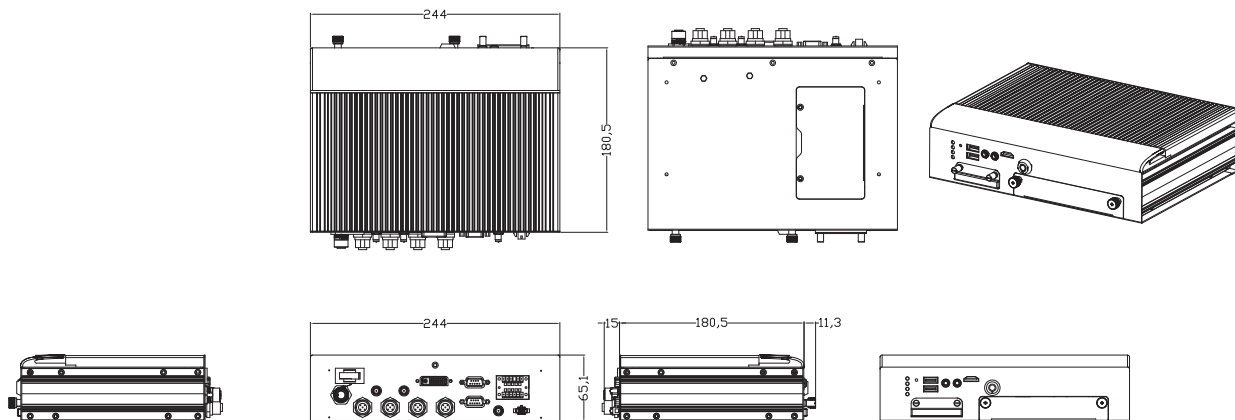

tBOX320-852-FL

Fanless Embedded System with Intel® Core™ 2 Duo Processor 2.26 GHz and Intel® GM45 for Railway PC

Intel® Core™2 Duo SP9300 2.26 GHz
or Intel® Celeron® M 723



Swappable HDD/CF

▲ Front view



Specifications

Standard Color	Silver-Black	
Construction	Aluminum extrusion and heavy-duty steel, IP40	
CPU	Intel® Core™ 2 Duo SP9300 2.26 GHz processor or Intel® Celeron® M 723 1.2 GHz processor	
System Memory	DDR3-1333 2 GB DRAM	
Chipset	Intel® GM45 + ICH9M	
BIOS	AMI	
System I/O Outlet	Rear Side	2 x GbE LAN (M12 D-coded) 4 x isolated RS-232/422/485 1 x isolated DI/DO (6-in/2-out) 4 x USB 2.0 2 x audio (mic-in/line-out) 1 x VGA 1 x DVI-D 1 x VDC power input (M12 A-coded) 1 x power switch 3 x antenna opening
	Front Side	2 x 2.5" SATA drive trays 1 x CFast™ slot 1 x SIM card socket
Watchdog Timer	255 levels, 1~255 sec.	
Storage	2 x 2.5" SATA HDD drive bay 1 x CompactFlash™	
Expansion Interface	2 x PCI Express Mini Card 1 x SIM card	
System Indicator	1 x green LED for system power-on 1 x red LED for HDD active 1 x green LED for LAN1 link 1 x green/yellow LED for LAN1 speed 1 x green LED for LAN2 link 1 x green/yellow LED for LAN2 speed	
Power Supply	DC 12~32V input with isolation support Default rating: DC24V M12 5-pin connector	
Power Consumption	6.7A @ 12V 3.4A @ 24V 2.5A @ 32V	
Operating Temperature	-25°C ~ +55°C (77°F ~ 130°F) (with W.T. HDD)	
Storage Temperature	-40°C ~ +80°C (-40°F ~ +176°F)	
Humidity	10% ~ 90%, non-condensing	
Vibration Endurance	2 Grms (5-500Hz, X, Y, Z directions)	

Features

- EN50155, EN50121 certificates
- Fanless with operation temperature range of -25°C ~ +55°C
- Comply to fire protection of railway vehicles Europe standard PrCEN TS 45545-2
- Supports onboard Intel® Core™ 2 Duo SP9300 2.26 GHz or Intel® Celeron® M 723 1.2 GHz processor
- Intel® GM45 + ICH9M
- 4 isolated RS-232/422/485 ports
- High performance DDR3-1333 2 GB DRAM
- One 2.5" swappable SATA drive bay, 1 internal SATA drive bay and one CompactFlash™
- 2 internal PCI Express Mini Card slots with 1 SIM slot
- Lockable I/O interface and M12 LAN connector

Mini Card slots

Full feature I/O



▲ Rear view Rugged M12 Ethernet conn.

10 ~ 35V wide range DC input

Dimensions	288 mm (11.33") (W) x 211 mm (8.3") (D) x 85.7 mm (3.37") (H)
Weight (net/gross)	5.06 kg (11.15 lb)/6.5 kg (14.33 lb)
Certificate	CE, EN50155, EN50121, EN45545, EN60950 compliance
EOS Support	XPE, WinCE, Linux

*XPE: Windows® XP Embedded

Ordering Information

Standard	
tBOX320-852-FL-2.26G-DC	Fanless railway embedded system with Intel® Core™ 2 Duo SP9300 2.26 GHz processor, 4 COM, 4 USB, CFast™, 2 HDD support, onboard 2 GB DDR3-1333 DRAM and 4-pin GbE LAN M12
tBOX320-852-FL-1.2G-DC	Fanless railway embedded system with Intel® Celeron® M 723 1.2 GHz processor, 4 COM, 4 USB, CFast™, 2 HDD support, onboard 2 GB DRAM and 4-pin GbE LAN M12
tBOX320-852-FL-2.26G-DC-G	Fanless railway embedded system with Intel® Core™ 2 Duo SP9300 2.26 GHz processor, 4 COM, 4 USB, CFast™, 2 HDD support, onboard 2 GB DDR3-1333 DRAM and 8-pin GbE LAN M12 (optional lockable HDD cover)
tBOX320-852-FL-1.2G-DC-G	Fanless railway embedded system with Intel® Celeron® M 723 1.2 GHz processor, 4 COM, 4 USB, CFast™, 2 HDD support, onboard 2 GB DDR3-1333 DRAM and 8-pin GbE LAN M12 (optional lockable HDD cover)

Optional

2.5" SATA HDD/SSD	40 GB or above
CompactFlash™	1 GB or above
3G module	
Wi-Fi module	
Wi-Fi Bluetooth	
GPS module	
Graphic accelerator codec	
M12 LAN cable	594N3202710E
M12 power cable	594B8120B30E
M12 Gigabit LAN cable	594N3202730E

*Specifications and certifications are based on options and may vary.

Expansion & Installation

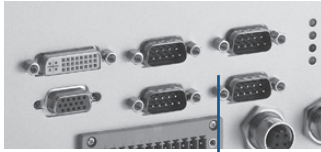

Lockable I/O connector



Easy access opening for HDD & CF

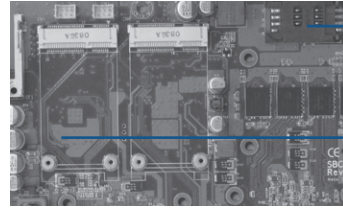

SIM slot

2 x Mini Card



M12 type connector

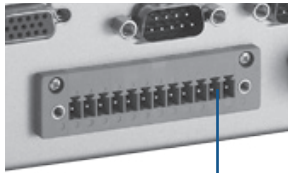

Isolated digital I/O

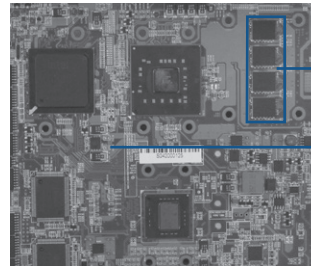

2 GB DDR3-1333 DRAM onboard

BGA type CPU & chipset

Packing List

- 1 x quick manual
- 1 x driver CD
- 1 x screw pack
- 4 x foot pad
- 8 x HDD anti-vibration damper
- 1 x wallmount Kit

Power Protection

DC Version

- OVP (over voltage protection)
- UVP (under voltage protection)
- SCP (short circuit protection)

Dimensions

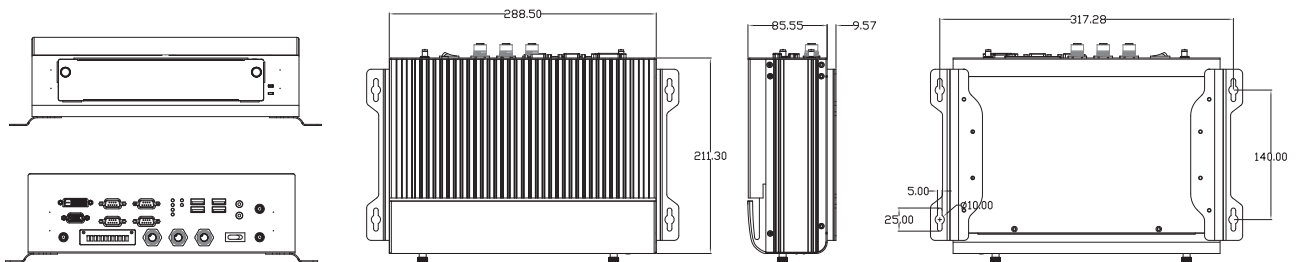

tBOX321-870-FL

Fanless Embedded System with 3rd Generation Intel® Core™ Processor and Intel® QM77 for Railway PC

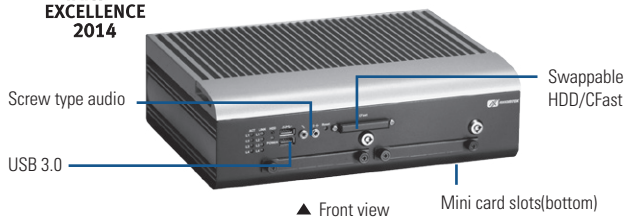

Specifications

Standard Color	Silver-Black				
Construction	Aluminum extrusion and heavy-duty steel, IP40				
CPU	3rd Generation Intel® Core™ i processor ; 3rd generation Intel® Core™ i7-3517UE (1.7 GHz up to 2.8 GHz) or 3rd generation Intel® Core™ i3-3217UE (1.6 GHz)				
System Memory	DDR3-1600 4 GB DRAM				
Chipset	Intel® QM77				
BIOS	AMI UEFI BIOS with OA 3.0 built				
System I/O Outlet	<table border="0"> <tr> <td>Rear Side</td> <td> 4 x GbE LAN (M12 A-coded) 4 x isolated RS-232/422/485 1 x isolated DI/DO (4-in/4-out) 1 x USB 2.0 (M12 A-coded) 1 x audio (mic-in/line-out, M12 D-coded) 1 x VGA 1 x DVI-D 1 x VDC power input (M12 A-coded) 1 x remote power switch 1 x power button 3 x antenna opening </td> </tr> <tr> <td>Front Side</td> <td> 2 x USB 3.0 2 x audio (mic-in/line-out, screw type) 1 x reset switch 2 x 2.5" SATA drive trays 1 x CFAST™ slot </td> </tr> </table>	Rear Side	4 x GbE LAN (M12 A-coded) 4 x isolated RS-232/422/485 1 x isolated DI/DO (4-in/4-out) 1 x USB 2.0 (M12 A-coded) 1 x audio (mic-in/line-out, M12 D-coded) 1 x VGA 1 x DVI-D 1 x VDC power input (M12 A-coded) 1 x remote power switch 1 x power button 3 x antenna opening	Front Side	2 x USB 3.0 2 x audio (mic-in/line-out, screw type) 1 x reset switch 2 x 2.5" SATA drive trays 1 x CFAST™ slot
Rear Side	4 x GbE LAN (M12 A-coded) 4 x isolated RS-232/422/485 1 x isolated DI/DO (4-in/4-out) 1 x USB 2.0 (M12 A-coded) 1 x audio (mic-in/line-out, M12 D-coded) 1 x VGA 1 x DVI-D 1 x VDC power input (M12 A-coded) 1 x remote power switch 1 x power button 3 x antenna opening				
Front Side	2 x USB 3.0 2 x audio (mic-in/line-out, screw type) 1 x reset switch 2 x 2.5" SATA drive trays 1 x CFAST™ slot				
Watchdog Timer	255 levels, 0 ~ 255 sec./min.				
Storage	2 x 2.5" SATA HDD (Removable and with lock protection) Supports RAID 0/1 1 x CFAST™				
Expansion Interface	3 x PCI Express Mini Card 1 x SIM card slot				
System Indicator	1 x green LED for system power on 1 x blue LED for HDD active 1 x green LED for LAN1 link 1 x green/yellow LED for LAN 1 speed 1 x green LED for LAN2 link 1 x green/yellow LED for LAN 2 speed 1 x green LED for LAN3 link 1 x green/yellow LED for LAN 3 speed 1 x green LED for LAN4 link 1 x green/yellow LED for LAN 4 speed				
Power Supply	Power input : 14VDC ~ 32VDC, 77 ~ 137.5VDC (isolation) Typical : 24, 110VDC				
Power Consumption	1.8A @ 24V, 0.5A @ 110V				

Features

- EN50155, EN50121 certificates
- Fanless with operating temperature range of -40°C ~ +70°C (EN50155 class TX)
- Comply to fire protection of railway vehicles Europe standard PrCEN TS 45545-2
- 3rd generation Intel® Core™ i7 1.7 GHz up to 2.8 GHz or Intel® Core™ i3 1.6 GHz processor
- High performance DDR3-1600 4 GB memory onboard
- Isolated RS-232/422/485 and DIO ports
- Supports USB 3.0 and SATA3 interface
- 2 removable & lockable 2.5" SATA HDD and 1 CFAST™
- 3 internal PCI Express Mini Card slot and 1 SIM slot
- Lockable I/O interface and M12 type LAN, audio, power and USB connector

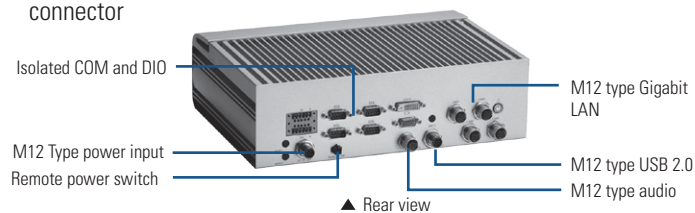

Operating Temperature	-40°C ~ +70°C (-40°F ~ +158°F) W/T SSD -25°C ~ +55°C (-13°F ~ +131°F) W/T HDD
Storage Temperature	-40°C ~ +80°C (-40°F ~ +176°F)
Humidity	5% ~ 95%, non-condensing
Vibration Endurance	Certificated by EN50155 standard 3 Grms with SSD & CFAST™ (5-500Hz, X, Y, Z direction; Random) 1 Grms with HDD (5-500Hz, X, Y, Z direction; Random)
Dimensions	288 mm (11.33") (W) x 211 mm (8.3") (D) x 85.7 mm (3.37") (H)
Weight (net/gross)	5.5 kg (12.12 lb)/6.5 kg (14.33 lb)
Certificate	CE (Class A), EN50155, EN50121, EN45545, EN60950 compliance
EOS Support	WEBS, WES 7, Linux

Ordering Information

Standard	
tBOX321-870-FL-i7-DC	Fanless railway embedded system with 3rd generation Intel® Core™ i7-3517UE, 4 GB DDR3-1600, 4 GbE LAN (M12), 4 isolated COM and CFAST™
tBOX321-870-FL-i3-DC	Fanless railway embedded system with 3rd generation Intel® Core™ i3-3217UE, 4 GB DDR3-1600, 4 GbE LAN (M12), 4 isolated COM and CFAST™
tBOX321-870-FL-i7-110VDC	Fanless railway embedded system with 3rd generation Intel® Core™ i7-3517UE, 4 GB DDR3-1600, 4 GbE LAN (M12), 4 isolated COM and CFAST™, 110VDC power input
tBOX321-870-FL-i3-110VDC	Fanless railway embedded system with 3rd generation Intel® Core™ i3-3217UE, 4 GB DDR3-1600, 4 GbE LAN (M12), 4 isolated COM and CFAST™, 110VDC power input

Optional	
2.5" SATA HDD/SSD	16 GB or above
CFAST™	1 GB or above
3G module	
Wi-Fi module	
Wi-Fi Bluetooth	
GPS module	
M12 Gigabit LAN cable	
M12 power cable	
M12 USB cable	
M12 audio cable	
Remote switch cable	
Power input voltage	24/110VDC

*Specifications and certifications are based on options and may vary.

Expansion & Installation

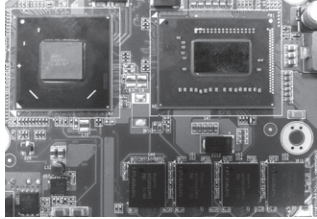

Onboard 3rd generation Intel® Core™ i7 or i3 processor and 4 GB DDR3-1600 DRAM



Swappable and lockable SATA3 HDD/SSD, audio jack, USB 3.0 & CFast™



M12 type for Gigabit LAN, USB 2.0 & audio port



M12 type power connector and remote switch connector

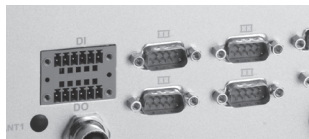

Isolated RS-232/422/485 & DIO ports



3 PCIe Mini Card slots with 1 SIM slot

Packing List

- 1 x quick manual
- 1 x driver CD
- 1 x screw pack
- 4 x foot pad
- 1 x wall-mount kit

Power Protection

DC Version

- SCP (short circuit protection)
- OVP (over voltage protection)
- UVP (under voltage protection)

Dimensions

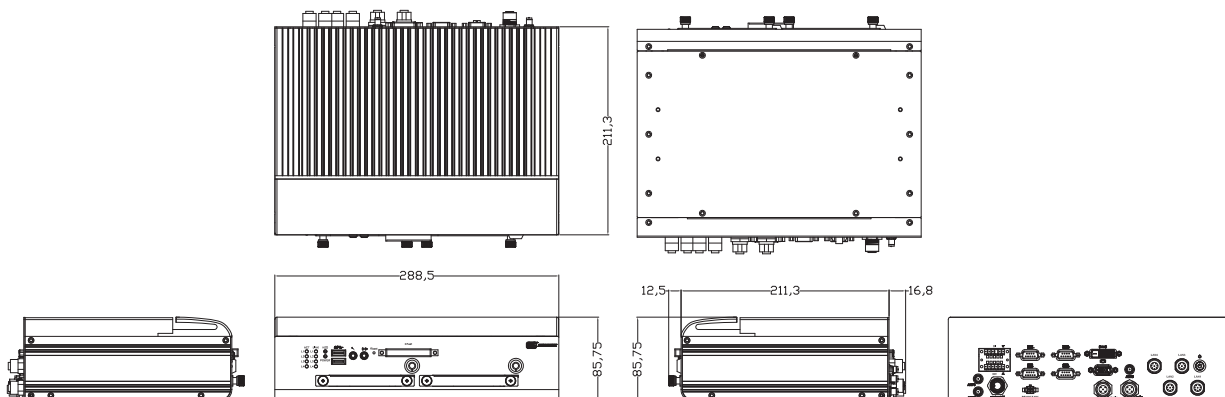

tBOX322-882-FL

Fanless Embedded System with
4th Generation Intel® Core™ Processor
for Railway PC

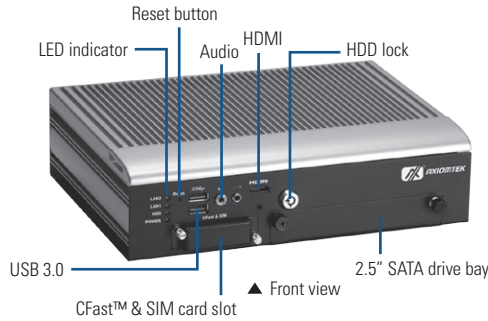

Specifications

Standard Color	Silver-Black				
Construction	Aluminum extrusion and heavy-duty steel, IP40				
CPU	4th Generation Intel® Core™ processor ; 4th generation Intel® Core™ i7-4650U (1.7 GHz up to 3.3 GHz) or 4th generation Intel® Core™ i3-4010U (1.7 GHz)				
System Memory	DDR3L-1600 4 GB or 8 GB DRAM				
Chipset	SoC integrated				
BIOS	AMI UEFI BIOS with OA 3.0 built				
System I/O Outlet	<table border="0"> <tr> <td>Rear Side</td> <td> <ul style="list-style-type: none"> 2 x GbE LAN (M12 A-coded) 2 x isolated RS-232/422/485 1 x isolated DI/DO (6-in/2-out) 1 x USB 2.0 (M12 A-coded) 1 x audio (mic-in/line-out, M12 D-coded) 1 x DVI-I 1 x VDC power input (M12 A-coded) 1 x remote power switch 4 x antenna opening 1 x power switch </td> </tr> <tr> <td>Front Side</td> <td> <ul style="list-style-type: none"> 2 x USB 3.0 2 x audio (mic-in/line-out, screw type) 1 x HDMI 1 x reset switch 1 x 2.5" SATA drive tray 1 x CFast™ slot + 2x SIM card sockets </td> </tr> </table>	Rear Side	<ul style="list-style-type: none"> 2 x GbE LAN (M12 A-coded) 2 x isolated RS-232/422/485 1 x isolated DI/DO (6-in/2-out) 1 x USB 2.0 (M12 A-coded) 1 x audio (mic-in/line-out, M12 D-coded) 1 x DVI-I 1 x VDC power input (M12 A-coded) 1 x remote power switch 4 x antenna opening 1 x power switch 	Front Side	<ul style="list-style-type: none"> 2 x USB 3.0 2 x audio (mic-in/line-out, screw type) 1 x HDMI 1 x reset switch 1 x 2.5" SATA drive tray 1 x CFast™ slot + 2x SIM card sockets
Rear Side	<ul style="list-style-type: none"> 2 x GbE LAN (M12 A-coded) 2 x isolated RS-232/422/485 1 x isolated DI/DO (6-in/2-out) 1 x USB 2.0 (M12 A-coded) 1 x audio (mic-in/line-out, M12 D-coded) 1 x DVI-I 1 x VDC power input (M12 A-coded) 1 x remote power switch 4 x antenna opening 1 x power switch 				
Front Side	<ul style="list-style-type: none"> 2 x USB 3.0 2 x audio (mic-in/line-out, screw type) 1 x HDMI 1 x reset switch 1 x 2.5" SATA drive tray 1 x CFast™ slot + 2x SIM card sockets 				
Watchdog Timer	255 levels, 0 ~ 255 sec./min.				
Storage	1 x 2.5" SATA HDD (Removable and with lock protection) 1 x CFast™				
Expansion Interface	3 x PCI Express Mini Card 2 x SIM card slots				
System Indicator	1 x green LED for system power on 1 x green LED for HDD active 1 x green LED for LAN1 link 1 x green LED for LAN2 link				
Power Supply	Power input : 14VDC ~ 32VDC (isolation) Typical : 24VDC				
Power Consumption	1.8A @ 24V				
Operating Temperature	-40°C ~ +70°C (-40°F ~ +158°F) W/T SSD -25°C ~ +55°C (-13°F ~ +131°F) W/T HDD				
Storage Temperature	-40°C ~ +80°C (-40°F ~ +176°F)				
Humidity	5% ~ 95%, non-condensing				

Features

- EN50155, EN50121 certificates
- Fanless with operating temperature range of -40°C ~ +70°C (EN50155 class TX)
- Comply to fire protection of railway vehicles Europe standard PrCEN TS 45545-2
- 4th generation Intel® Core™ i7 or Core™ i3 processor
- High performance DDR3L 4 GB or 8 GB memory onboard
- Isolated RS-232/422/485 and DIO ports
- Supports USB 3.0 and SATA3 interface
- 1 removable & lockable 2.5" SATA HDD and 1 CFast™
- 3 internal PCI Express Mini Card slot and 2 SIM slots
- Lockable I/O interface and M12 type LAN, audio, power and USB connector
- Suspension designed for HDD

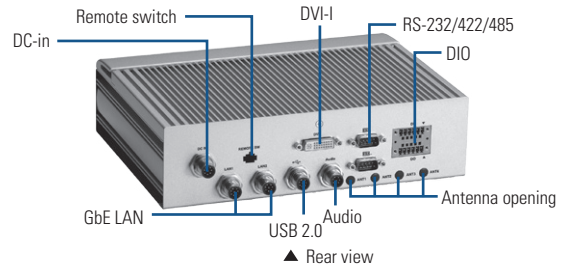

Vibration Endurance	3 Grms with SSD or CFast™ (5-500Hz, X, Y, Z directions) 2 Grms with HDD (5-500Hz, X, Y, Z directions)
Dimensions	244 mm (9.6") (W) x 180.5 mm (7.1") (D) x 65.1 mm (2.56") (H)
Weight (net/gross)	2.94 kg (6.48 lb)/ 3.94 kg (8.68 lb)
Certificate	CE (Class A), EN50155, EN50121, EN45545-2, EN60950-1 compliance
EOS Support	WEBS, WES 7, Linux

Ordering Information

Standard	
tBOX322-882-FL-i7-DC	Fanless railway embedded system with 4th generation Intel® Core™ i7-4650U, 4 GB DDR3L, 2 GbE LAN (M12), 2 isolated COM and CFast™
tBOX322-882-FL-i3-DC	Fanless railway embedded system with 4th generation Intel® Core™ i3-4010U, 4 GB DDR3L, 2 GbE LAN (M12), 2 isolated COM and CFast™
tBOX322-882-FL-8GB-i7-DC	Fanless railway embedded system with 4th generation Intel® Core™ i7-4650U, 8 GB DDR3L, 2 GbE LAN (M12), 2 isolated COM and CFast™
tBOX322-882-FL-8GB-i3-DC	Fanless railway embedded system with 4th generation Intel® Core™ i3-4010U, 8 GB DDR3L, 2 GbE LAN (M12), 2 isolated COM and CFast™
Optional	
2.5" SATA HDD/SSD	16 GB or above
CFast™	1 GB or above
3G module	
Wi-Fi module	
Wi-Fi Bluetooth	
GPS module	
M12 Gigabit LAN cable	
M12 power cable	
M12 USB cable	
M12 audio cable	
Remote switch cable	

*Specifications and certifications are based on options and may vary.

Expansion & Installation

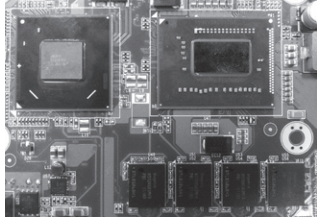

Onboard 4th generation Intel® Core™ CPU and 4 GB/ 8 GB DDR3L DRAM



Swappable and lockable SATA3 HDD/SSD, Audio jack, USB 3.0 and CFast™

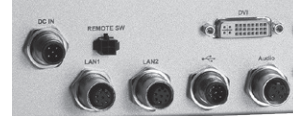

M12 type for Gigabit LAN, USB 2.0 and audio ports

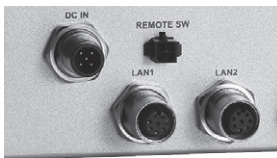

M12 type power connector and remote switch connector

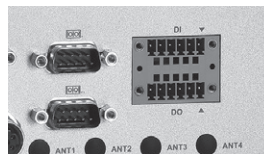

Isolated RS-232/422/485 and DIO ports

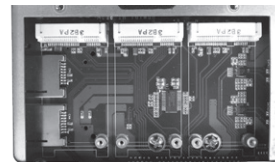

3 x Mini Card slots with 2 x SIM slot

Packing List

- 1 x quick manual
- 1 x driver CD
- 1 x screw pack
- 4 x foot pad
- 1 x wall-mount kit

Power Protection

DC Version

- SCP (short circuit protection)
- OVP (over voltage protection)
- UVP (under voltage protection)

Dimensions

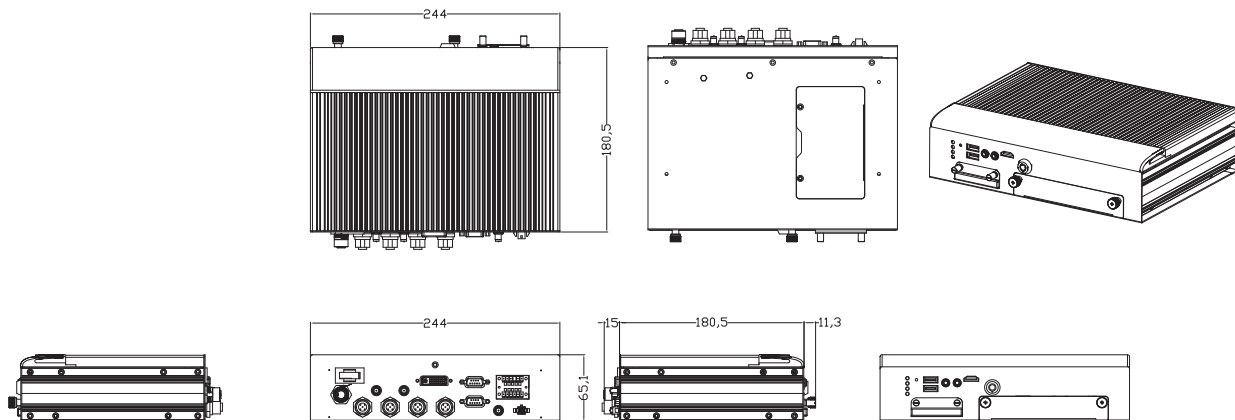

tBOX322-882-FL

Fanless Embedded System with
4th Generation Intel® Core™ Processor
for Railway PC

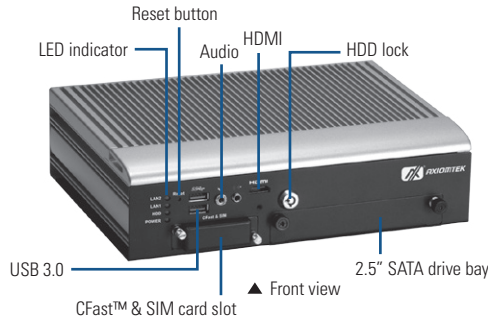

Specifications

Standard Color	Silver-Black
Construction	Aluminum extrusion and heavy-duty steel, IP40
CPU	4th Generation Intel® Core™ processor ; 4th generation Intel® Core™ i7-4650U (1.7 GHz up to 3.3 GHz) or 4th generation Intel® Core™ i3-4010U (1.7 GHz)
System Memory	DDR3L-1600 4 GB or 8 GB DRAM
Chipset	SoC integrated
BIOS	AMI UEFI BIOS with OA 3.0 built
System I/O Outlet	Rear Side <ul style="list-style-type: none"> 2 x GbE LAN (M12 A-coded) 2 x isolated RS-232/422/485 1 x isolated DI/DO (6-in/2-out) 1 x USB 2.0 (M12 A-coded) 1 x audio (mic-in/line-out, M12 D-coded) 1 x DVI-I 1 x VDC power input (M12 A-coded) 1 x remote power switch 4 x antenna opening 1 x power switch Front Side <ul style="list-style-type: none"> 2 x USB 3.0 2 x audio (mic-in/line-out, screw type) 1 x HDMI 1 x reset switch 1 x 2.5" SATA drive tray 1 x CFast™ slot + 2x SIM card sockets
Watchdog Timer	255 levels, 0 ~ 255 sec./min.
Storage	1 x 2.5" SATA HDD (Removable and with lock protection) 1 x CFast™
Expansion Interface	3 x PCI Express Mini Card 2 x SIM card slots
System Indicator	1 x green LED for system power on 1 x green LED for HDD active 1 x green LED for LAN1 link 1 x green LED for LAN2 link
Power Supply	Power input : 14VDC ~ 32VDC (isolation) Typical : 24VDC
Power Consumption	1.8A @ 24V
Operating Temperature	-40°C ~ +70°C (-40°F ~ +158°F) W/T SSD -25°C ~ +55°C (-13°F ~ +131°F) W/T HDD
Storage Temperature	-40°C ~ +80°C (-40°F ~ +176°F)
Humidity	5% ~ 95%, non-condensing

Features

- EN50155, EN50121 certificates
- Fanless with operating temperature range of -40°C ~ +70°C (EN50155 class TX)
- Comply to fire protection of railway vehicles Europe standard PrCEN TS 45545-2
- 4th generation Intel® Core™ i7 or Core™ i3 processor
- High performance DDR3L 4 GB or 8 GB memory onboard
- Isolated RS-232/422/485 and DIO ports
- Supports USB 3.0 and SATA3 interface
- 1 removable & lockable 2.5" SATA HDD and 1 CFast™
- 3 internal PCI Express Mini Card slot and 2 SIM slots
- Lockable I/O interface and M12 type LAN, audio, power and USB connector
- Suspension designed for HDD

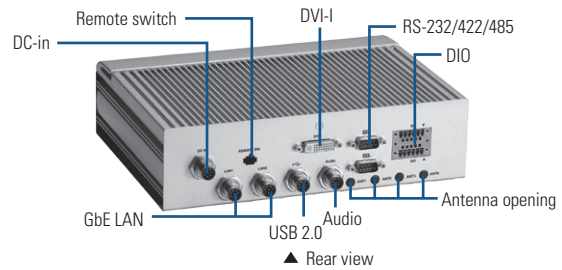

Vibration Endurance	3 Grms with SSD or CFast™ (5-500Hz, X, Y, Z directions) 2 Grms with HDD (5-500Hz, X, Y, Z directions)
Dimensions	244 mm (9.6") (W) x 180.5 mm (7.1") (D) x 65.1 mm (2.56") (H)
Weight (net/gross)	2.94 kg (6.48 lb)/ 3.94 kg (8.68 lb)
Certificate	CE (Class A), EN50155, EN50121, EN45545-2, EN60950-1 compliance
EOS Support	WEBS, WES 7, Linux

Ordering Information

Standard	
tBOX322-882-FL-i7-DC	Fanless railway embedded system with 4th generation Intel® Core™ i7-4650U, 4 GB DDR3L, 2 GbE LAN (M12), 2 isolated COM and CFast™
tBOX322-882-FL-i3-DC	Fanless railway embedded system with 4th generation Intel® Core™ i3-4010U, 4 GB DDR3L, 2 GbE LAN (M12), 2 isolated COM and CFast™
tBOX322-882-FL-8GB-i7-DC	Fanless railway embedded system with 4th generation Intel® Core™ i7-4650U, 8 GB DDR3L, 2 GbE LAN (M12), 2 isolated COM and CFast™
tBOX322-882-FL-8GB-i3-DC	Fanless railway embedded system with 4th generation Intel® Core™ i3-4010U, 8 GB DDR3L, 2 GbE LAN (M12), 2 isolated COM and CFast™
Optional	
2.5" SATA HDD/SSD	16 GB or above
CFast™	1 GB or above
3G module	
Wi-Fi module	
Wi-Fi Bluetooth	
GPS module	
M12 Gigabit LAN cable	
M12 power cable	
M12 USB cable	
M12 audio cable	
Remote switch cable	

*Specifications and certifications are based on options and may vary.

Expansion & Installation

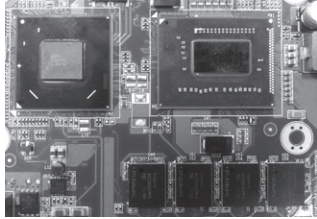

Onboard 4th generation Intel® Core™ CPU and 4 GB/ 8 GB DDR3L DRAM



Swappable and lockable SATA3 HDD/SSD, Audio jack, USB 3.0 and CFast™

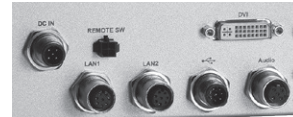

M12 type for Gigabit LAN, USB 2.0 and audio ports



M12 type power connector and remote switch connector

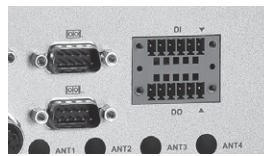

Isolated RS-232/422/485 and DIO ports

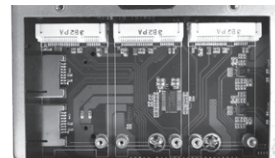

3 x Mini Card slots with 2 x SIM slot

Packing List

- 1 x quick manual
- 1 x driver CD
- 1 x screw pack
- 4 x foot pad
- 1 x wall-mount kit

Power Protection

DC Version

- SCP (short circuit protection)
- OVP (over voltage protection)
- UVP (under voltage protection)

Dimensions

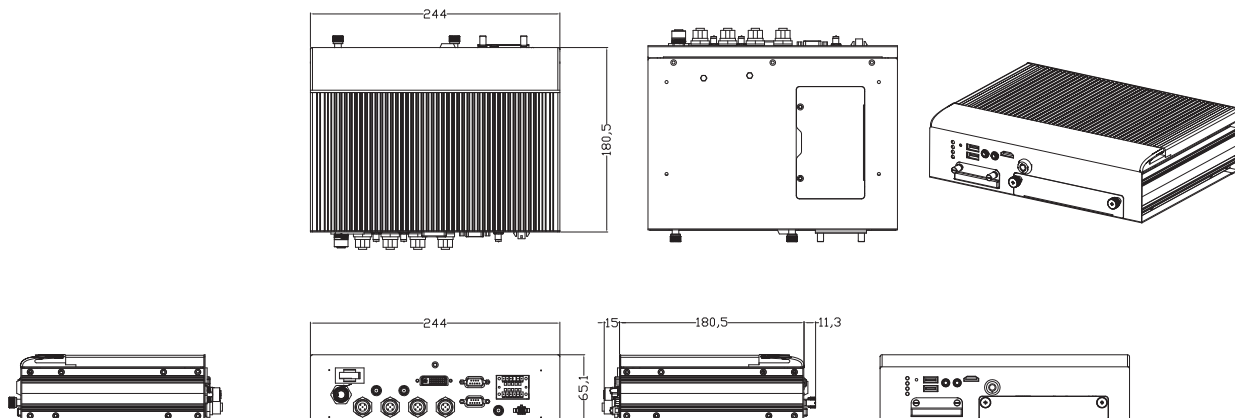

tBOX323-835-FL

Fanless Embedded System with Intel® Atom™ Processor E3845 Quad Core™ (1.91 GHz) for Railway PC

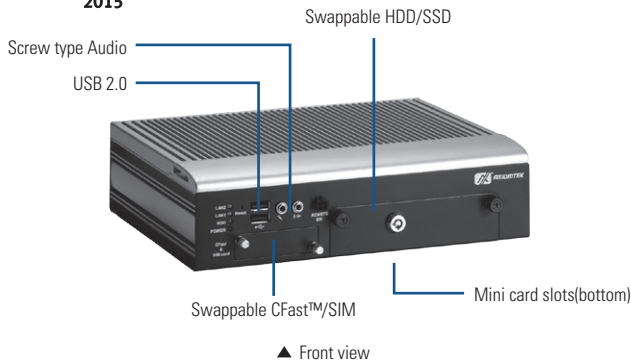

▲ Front view



Features

- EN50155, EN50121 certified, EN45545-2 complied
- Fanless operating temperature range of -40°C ~ +70°C (EN50155 class TX)
- Intel® Atom™ Bay Trail-I E3845 4C@1.91GHz
- High performance DDR3L-1333 4 GB memory onboard
- Isolated RS-422/485 and DIO
- Lockable I/O interface and M12 LAN, power connector
- Supports USB 2.0 and SATA2
- Instant fuse repair design
- Suspension 2.5" SATA HDD and one CFast™
- Internal PCI Express Mini Card slot and SIM socket

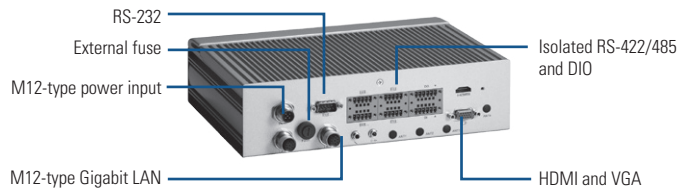

▲ Rear view

Specifications

Standard Color	Silver-Black
Construction	Aluminum extrusion and heavy-duty steel
CPU	Intel® Atom™ processor E3845 (4C@1.91GHz)
System Memory	DDR3L-1333, 4 GB memory
Chipset	SoC integrated
BIOS	AMI
System I/O Outlet	Rear Side 2 x GbE LAN (M12 A-coded) 4 x isolated RS-422/485 (terminal) 1 x RS-232 (DB9) 1 x isolated DI/DO (6-in/2-out) 2 x audio (mic-in/line-out, screw type) 1 x HDMI 1 x VGA 1 x VDC power input (M12 A-coded) 4 x antenna opening 1 x fuse Front Side 2 x USB 2.0 1 x audio (mic-in/line-out, screw type) 1 x reset switch 1 x remote power switch 1 x 2.5" SATA drive tray 1 x CFast™ slot + 2 x SIM card sockets
Watchdog Timer	255 levels, 0 ~ 255 seconds/minutes
Storage	1 x 2.5" SATA HDD(Suspension designed, HDD height support 7/9.5/12.5/15mm) 1 x CFast™ (front accessible)
Expansion Interface	3 x PCI Express Mini Card with 2 x SIM card slots (two front accessible) One PCIe mini card support mSATA
System Indicator	1 x green LED for HDD active 1 x yellow LED for LAN1 active 1 x yellow LED for LAN2 active 1 x red LED for Power
Power Supply	Power input : 12 ~ 32 Vdc (typical 24Vdc)
Operating Temperature	-40°C ~ +70°C (-40°F ~ +158°F) with W/T SSD -25°C ~ +55°C (-13°F ~ +131°F) with W/T HDD
Storage Temperature	-40°C ~ +80°C (-40°F ~ +176°F)
Humidity	5% ~ 95%, non-condensing

Vibration Endurance	3 Grms with SSD & CFast™ (5-500Hz, X, Y, Z direction; Random) (IEC60068-2-34) 2 Grms with HDD (5-500Hz, X, Y, Z direction; Random)
Shock	Comply EN 61373 section 10 table 3 category 1 class A and class B up to 5Grms (30ms, ±X/Y/Z direction)
Dimensions	244 mm (9.6") (W) x 180.5 mm (7.1") (D) x 65.1 mm (2.56") (H)
Weight (net/gross)	3 kg (6.61 lb)/ 3.8 kg (8.38 lb)
Certificate	CE, EN50155, EN50121, EN45545-2 compliance
EOS support	WES7/8, Compac2013, Linux

Ordering Information

Standard	
tBOX323-835-FL-DC	Fanless railway embedded system with Intel® Atom™ E3845 (4C@1.91 GHz), 4 GB DDR3-1333, 2 GbE LAN (M12), 1 RS-232, 4 isolated RS-422/485, and CFast™

Optional	
2.5" SATA HDD/SSD	16 GB or above
CFast™	1 GB or above
3G module	
Wi-Fi module	
Wi-Fi & bluetooth	
GPS module	
M12 Gigabit LAN cable	
M12 power cable	
Remote switch cable	

*Specifications and certifications are based on options and may vary.

Expansion & Installation

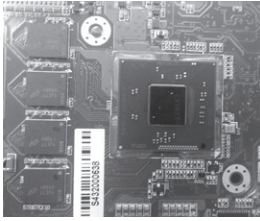

On board Intel® Atom™ Bay Trail-I (E3845, 4C@ 1.91GHz) processor and 4GB DDR3L-1333 DRAM



Removable CFast™, SIM slot and suspension 2.5" SATA HDD/SSD



M12 railway power input and two Gigabit LAN connectors



HDMI and VGA display

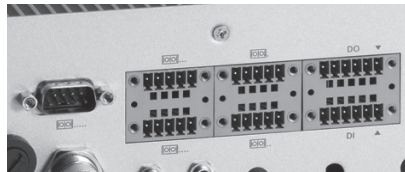

Isolated RS-422/485 and DIO

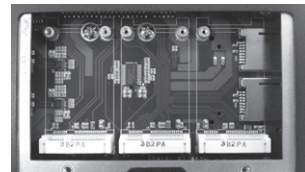

3 x Mini Card with 2 x SIM slot

Packing List

- 1 x quick manual
- 1 x driver CD
- 1 x screw pack
- 4 x foot pad
- 1 x wall-mount kit

Power Protection

DC Version

- SCP (short circuit protection)
- OVP (over voltage protection)
- UVP (under voltage protection)

Dimensions

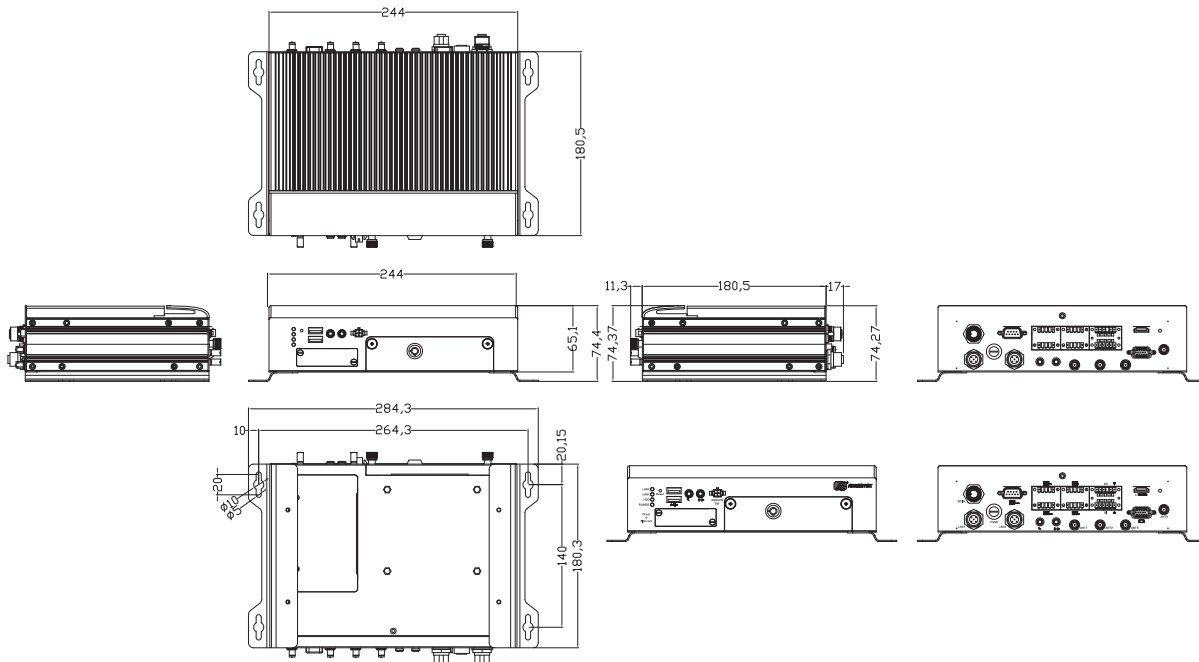

tBOX330-870-FL

Fanless Embedded System with 3rd Generation Intel® Core™ Processor and Intel® QM77 for Marine PC

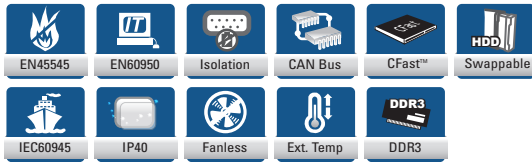
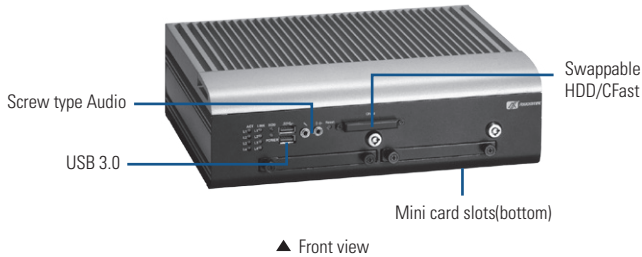

Specifications

Standard Color	Silver-Black				
Construction	Aluminum extrusion and heavy-duty steel, IP40				
CPU	3rd generation Intel® Core™ i processor ; 3rd generation Intel® Core™ i7-3517UE (1.7 GHz up to 2.8 GHz) or 3rd generation Intel® Core™ i3-3217UE (1.6 GHz)				
System Memory	DDR3-1600 4 GB DRAM				
Chipset	Intel® QM77				
BIOS	AMI UEFI BIOS with OA 3.0 built				
System I/O Outlet	<table border="0"> <tr> <td>Rear Side</td> <td> 4 x GbE 3 x isolated RS-232/422/485 1 x isolated DI/DO (4-in/4-out) 1 x isolated CAN Bus 2 x USB 2.0 2 x audio (mic-in/line-out, screw type) 1 x VGA 1 x DVI-D 1 x VDC power input 1 x remote power switch 4 x antenna opening </td> </tr> <tr> <td>Front Side</td> <td> 2 x USB 3.0 2 x audio (mic-in/line-out, screw type) 1 x reset switch 2 x 2.5" SATA drive trays 1 x CFast™ slot </td> </tr> </table>	Rear Side	4 x GbE 3 x isolated RS-232/422/485 1 x isolated DI/DO (4-in/4-out) 1 x isolated CAN Bus 2 x USB 2.0 2 x audio (mic-in/line-out, screw type) 1 x VGA 1 x DVI-D 1 x VDC power input 1 x remote power switch 4 x antenna opening	Front Side	2 x USB 3.0 2 x audio (mic-in/line-out, screw type) 1 x reset switch 2 x 2.5" SATA drive trays 1 x CFast™ slot
Rear Side	4 x GbE 3 x isolated RS-232/422/485 1 x isolated DI/DO (4-in/4-out) 1 x isolated CAN Bus 2 x USB 2.0 2 x audio (mic-in/line-out, screw type) 1 x VGA 1 x DVI-D 1 x VDC power input 1 x remote power switch 4 x antenna opening				
Front Side	2 x USB 3.0 2 x audio (mic-in/line-out, screw type) 1 x reset switch 2 x 2.5" SATA drive trays 1 x CFast™ slot				
Watchdog Timer	255 levels, 0 ~ 255 sec./min.				
Storage	2 x 2.5" SATA HDD (Removable and with lock protection) supports RAID 0/1 1 x CFast™				
Expansion Interface	3 x PCI Express Mini Card 1 x SIM card slot				
System Indicator	1 x green LED for system power on 1 x blue LED for HDD active 1 x green LED for LAN1 link 1 x green/yellow LED for LAN 1 speed 1 x green LED for LAN2 link 1 x green/yellow LED for LAN 2 speed 1 x green LED for LAN3 link 1 x green/yellow LED for LAN 3 speed 1 x green LED for LAN4 link 1 x green/yellow LED for LAN 4 speed				

Features

- IEC60945 certificate
- Comply to fire protection of railway vehicles Europe standard PrCEN TS 45545-2
- 3rd generation Intel® Core™ i7 1.7 GHz up to 2.8 GHz or Intel® Core™ i3 1.6 GHz processor
- High performance DDR3-1600 4 GB memory onboard
- Fanless with operating temperature range of -40°C ~ +70°C
- Isolated RS-232/422/485, CAN bus and DIO ports
- Supports USB 3.0 and SATA3 interface
- 2 removable & lockable 2.5" SATA HDD and 1 CFast™
- 3 internal PCI Express Mini Card slot and 1 SIM slot

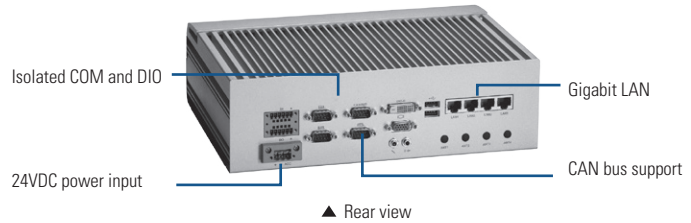

Power Supply	Power input : 14~32VDC, Typical 24VDC
Power Consumption	1.8A @ 24V
Operating Temperature	-40°C ~ +70°C (-40°F ~ +158°F) W/T SSD -25°C ~ +55°C (-13°F ~ +131°F) W/T HDD
Storage Temperature	-40°C ~ +80°C (-40°F ~ +176°F)
Humidity	5% ~ 95%, non-condensing
Vibration Endurance	5 Grms with CFast™ (5-500Hz, X, Y, Z directions) 1 Grms with HDD (5-500Hz, X, Y, Z directions)
Dimensions	288 mm (11.33") (W) x 211 mm (8.3") (D) x 85.7 mm (3.37") (H)
Weight (net/gross)	5.5 kg (12.12 lb)/6.5 kg (14.33 lb)
Certificate	CE (Class A), IEC60945 certificate, EN45545-2 compliance
EOS Support	WEBS, WES 7, Linux

Ordering Information

Standard	
tBOX330-870-FL-i7-DC	Fanless marine embedded system with 3rd generation Intel® Core™ i7 processor, 4GB DDR3-1600, 4 GbE LAN, 3 isolated COM, CFast™ and isolated CAN bus
tBOX330-870-FL-i3-DC	Fanless marine embedded system with 3rd generation Intel® Core™ i3 processor, 4GB DDR3-1600, 4 GbE LAN, 3 isolated COM, CFast™ and isolated CAN bus

Optional	
2.5" SATA HDD/SSD	16 GB or above
CFast™	1 GB or above
3G module	
Wi-Fi module	
Wi-Fi Bluetooth	
GPS module	

*Specifications and certifications are based on options and may vary.

Expansion & Installation

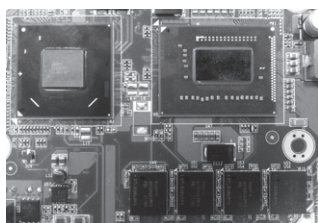

Onboard 3rd generation Intel® Core™ i7 or i3 processor and 4 GB DDR3-1600 DRAM



Swappable and Lockable SATA3 HDD/SSD, Audio jack, USB 3.0 and CFast

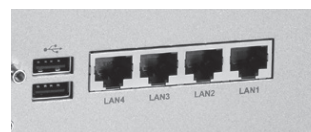

Four Gigabit LAN ports



24VDC power input

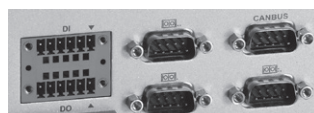

Isolated RS-232/422/485, CAN bus and DIO



3 PCIe Mini Card slots with 1 SIM slot

Dimensions

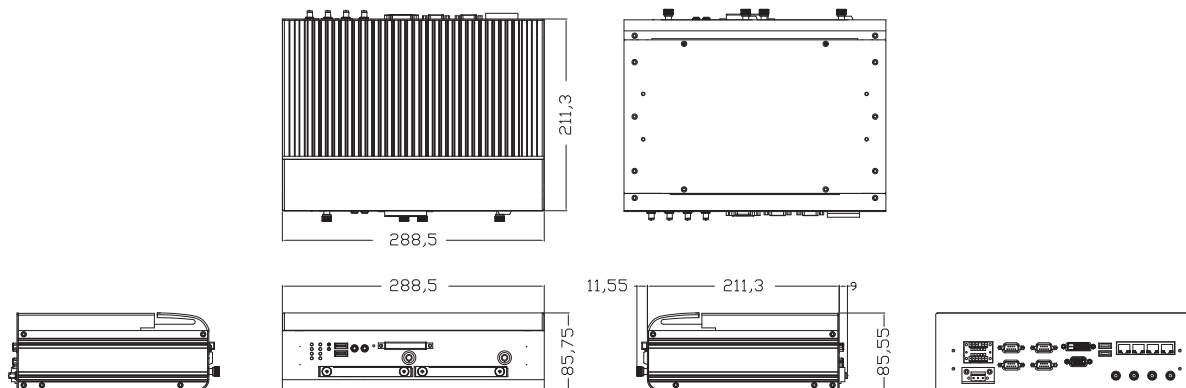

Архангельск (8182)63-90-72
 Астана +7(7172)727-132
 Белгород (4722)40-23-64
 Брянск (4832)59-03-52
 Владивосток (423)249-28-31
 Волгоград (844)278-03-48
 Вологда (8172)26-41-59
 Воронеж (473)204-51-73
 Екатеринбург (343)384-55-89
 Иваново (4932)77-34-06
 Ижевск (3412)26-03-58
 Казань (843)206-01-48

Калининград (4012)72-03-81
 Калуга (4842)92-23-67
 Кемерово (3842)65-04-62
 Киров (8332)68-02-04
 Краснодар (861)203-40-90
 Красноярск (391)204-63-61
 Курск (4712)77-13-04
 Липецк (4742)52-20-81
 Магнитогорск (3519)55-03-13
 Москва (495)268-04-70
 Мурманск (8152)59-64-93
 Набережные Челны (8552)20-53-41

Нижний Новгород (831)429-08-12
 Новокузнецк (3843)20-46-81
 Новосибирск (383)227-86-73
 Орел (4862)44-53-42
 Оренбург (3532)37-68-04
 Пенза (8412)22-31-16
 Пермь (342)205-81-47
 Ростов-на-Дону (863)308-18-15
 Рязань (4912)46-61-64
 Самара (846)206-03-16
 Санкт-Петербург (812)309-46-40
 Саратов (845)249-38-78

Смоленск (4812)29-41-54
 Сочи (862)225-72-31
 Ставрополь (8652)20-65-13
 Тверь (4822)63-31-35
 Томск (3822)98-41-53
 Тула (4872)74-02-29
 Тюмень (3452)66-21-18
 Ульяновск (8422)24-23-59
 Уфа (347)229-48-12
 Челябинск (351)202-03-61
 Череповец (8202)49-02-64
 Ярославль (4852)69-52-93